

**Technical Note - TN21**

**Derivative time-domain sensor verification procedure**

*Marc Sallin and Bertrand Daout, montena technology, 1728 Rossens, Switzerland*

Table of contents

1. Introduction .....	1
2. Verification setup.....	1
3. Generator.....	2
4. TEM cell.....	3
5. Attenuator and coaxial cables .....	3
6. Combination "field sensor + integrator".....	4
7. Oscilloscope.....	4
8. Correction factor summary .....	6
9. Verification procedure.....	7

**1. Introduction**

The goal of this technical note is to describe the setup needed for the verification of D-dot and B-dot sensors in time-domain, to present the important parameters and the equations that enable the calculation of the sensor correction factor. Note that no international recognized calibration method exists up to now and only verification process can be carried out.

The basic idea is to create a well defined pulsed electromagnetic field inside a TEM cell and to compare this time-domain field waveform with the output of the field sensor.

This technical note refers to sensors which are controlled with respect to a specific field. The case of sensors uniquely verified by the measurement of their mechanical dimension is detailed in TN08-15 Derivative time-domain sensor and fibre optic correction factor calculation. Please refer to that technical note for further details.

**2. Verification setup**

A general schematic and a picture of the verification setup are shown below.

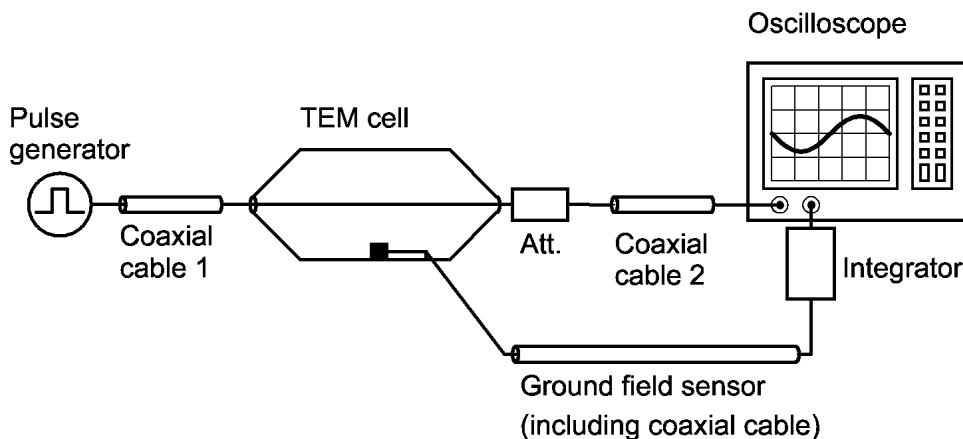

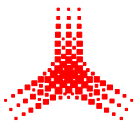

# montena

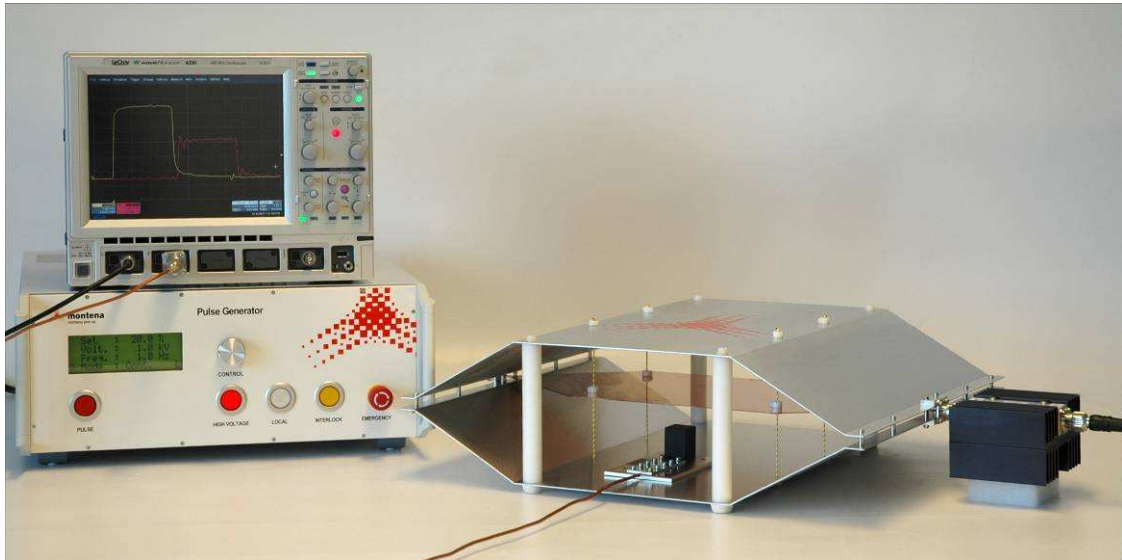

It consists of the following devices:

- Pulse generator
- TEM cell
- Attenuator
- Coaxial cables
- Oscilloscope
- Electric or magnetic field sensor with integrator to be verified.

Each above mentioned device has some important parameters for the verification. The description for each device is given in the following paragraphs.

### 3. Generator

The generator delivers a high voltage square pulse signal. The rise-time and the duration of the pulse determine the frequency range of the verification. The attenuation of the coaxial cable 1 from the pulse generator to the TEM cell does not need to be known as the voltage is measured at the output of the TEM cell.

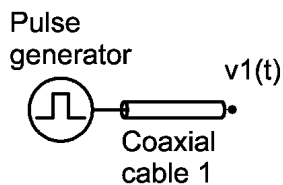

Verification procedure of the pulse generator:

- Measurement of the characteristics of  $v_1(t)$  to be performed on a 50 ohm load located at the end of cable 1. Rise-time, duration, amplitude.

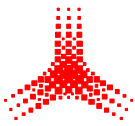

## 4. TEM cell

The TEM cell transforms the square pulse voltage into a homogeneous electromagnetic field.

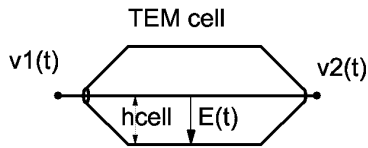

The sensor dimensions must be small in comparison with the height of the cell. It must be located in the middle and have a good high frequency electrical contact with the ground plane of the cell. The orientation of the sensor must be adapted to the field polarisation for which the sensor is verified (inside the TEM cell, the electric field is vertically polarised and the magnetic field is horizontally polarised).

As long as the signal is within the frequency range of the TEM cell, the radiation losses can be considered as negligible and the voltage in the middle of the cell can be considered to be equal to  $v_2(t)$ .

The equations for the electric and the magnetic field inside the cell are the following:

$$E(t) = \frac{v_2(t)}{h_{\text{cell}}} \quad (1)$$

$$H(t) = \frac{v_2(t)}{Z_0 \cdot h_{\text{cell}}} \quad (2)$$

where:

$h_{\text{cell}}$  is the distance between the septum and the ground plane of the TEM cell.

$Z_0$  is the impedance of free-space, 377 ohm.

Verification procedure of the TEM cell:

- Measurement of the transmission characteristic ( $S_{21}$ ) with a network analyser.
- Measurement of the reflexion characteristics ( $S_{11}$ ) with a network analyser.
- Measurement of the distance between the septum and the ground,  $h_{\text{cell}}$ .

## 5. Attenuator and coaxial cables

The goal of the attenuator is to protect the input channel of the oscilloscope. The value must be chosen so that the voltage  $v_3(t)$  is always below the maximum input voltage of the oscilloscope.

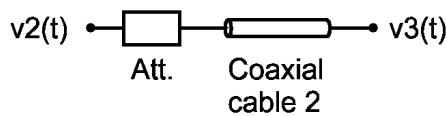

The equation is the following:

$$v_3(t) = \frac{v_2(t)}{10^{\frac{K_{\text{Att}}}{20}}} \quad (3)$$

where:

$K_{\text{Att}}$  is the attenuation of the attenuator and the coaxial cable 2 in dB.

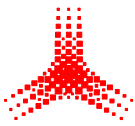

The losses of the attenuator and the coaxial cables forming the measurement chain can be considered as a single attenuation. At high frequencies, coaxial cables can no more be seen as perfect elements, as they show some attenuation which is dependant on the frequency (low-pass effect).  $K_{Att}$  must be measured with a network analyser, in order to check the deviation of the attenuation from the nominal value.

Verification procedure of the attenuator and coaxial cables:

- Measurement of the transmission characteristic ( $S_{21}$ ) with a network analyser.

## 6. Combination "field sensor + integrator"

The verification is performed for the combination of the field sensor and its dedicated integrator. The output cable of the field sensor must be connected directly to the integrator. The integrator has a high output impedance, so it must have a direct connection to the 1 Mohm input channel of the oscilloscope.

The derivative behaviour of the field sensor is compensated by the integrator to obtain a flat frequency response. This results in a correction factor which is constant on a wide frequency range.

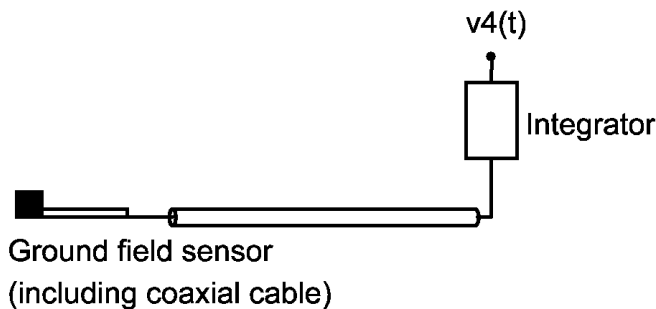

## 7. Oscilloscope

The oscilloscope records the voltage representing the electromagnetic field in the TEM cell  $v_3(t)$  and the output voltage of the combination "electric or magnetic field sensor + integrator"  $v_4(t)$ . The coupling of the channel measuring  $v_3(t)$  must be set to 50 ohm and the coupling of the channel measuring  $v_4(t)$  must be set to 1 Mohm.

A correct frequency response of the oscilloscope channel with 1 Mohm coupling must be ensured. Montena can provide data about the frequency response of different oscilloscopes with 1 Mohm coupling.

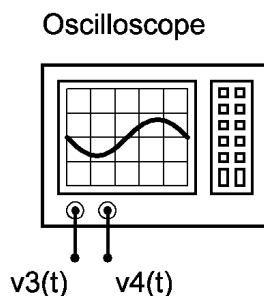

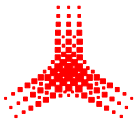

The frequency response of oscilloscopes with 1 Mohm coupling can also vary with the selected vertical sensitivity. The following picture shows the response of the oscilloscope for the same square pulse with two different vertical sensitivities. Both measurements are displayed with the same scale for the comparison.

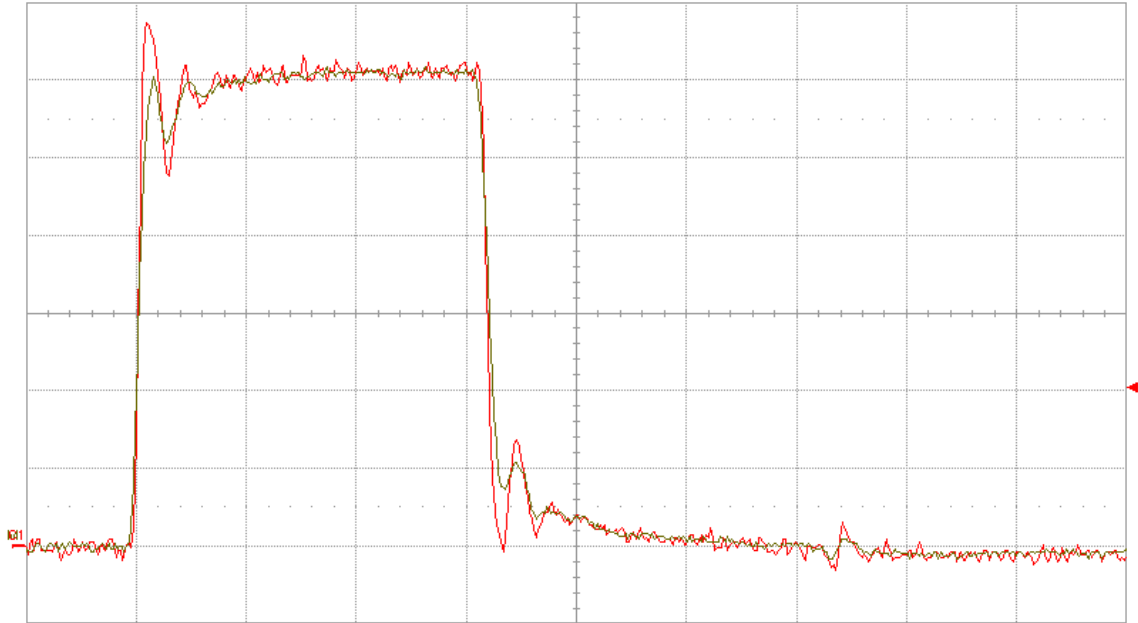

Verification procedure of the oscilloscope:

- Measurement of the frequency response.

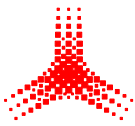

## 8. Correction factor summary

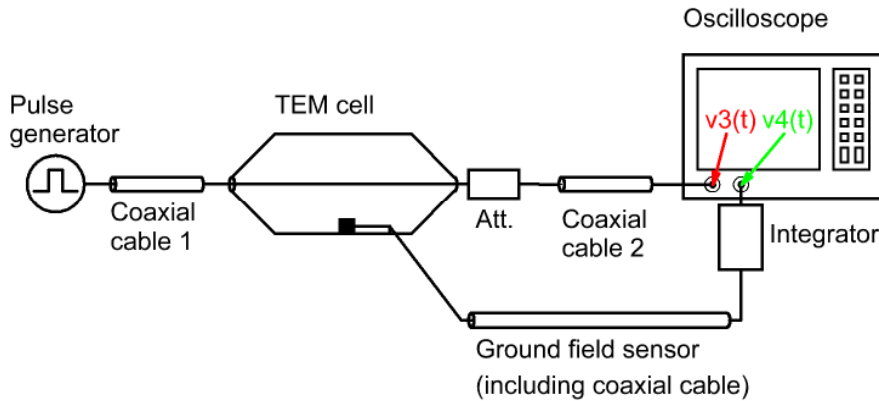

According to the above mentioned contributions, the correction factor  $K_{\text{sensor}}$  of the combination "field sensor + integrator" is calculated as follows:

for an electric field sensor	for a magnetic field sensor
$K_{\text{sensor}} = \frac{E(t)}{v_4(t)} \quad (4)$	$K_{\text{sensor}} = \frac{H(t)}{v_4(t)} \quad (7)$
$\text{with } E(t) = \frac{v_3(t) \cdot 10^{\frac{K_{\text{Att}}}{20}}}{h_{\text{cell}}} \quad (5)$	$\text{with } H(t) = \frac{v_3(t) \cdot 10^{\frac{K_{\text{Att}}}{20}}}{Z_0 \cdot h_{\text{cell}}} \quad (8)$
$K_{\text{sensor}} = \frac{v_3(t) \cdot 10^{\frac{K_{\text{Att}}}{20}}}{v_4(t) \cdot h_{\text{cell}}} \quad (6)$	$K_{\text{sensor}} = \frac{v_3(t) \cdot 10^{\frac{K_{\text{Att}}}{20}}}{v_4(t) \cdot Z_0 \cdot h_{\text{cell}}} \quad (9)$

where:

$K_{\text{Att}}$  is the attenuation of the combination of the attenuator and the coaxial cables in dB.

$h_{\text{cell}}$  is the distance between the septum and the ground plane of the TEM cell.

$Z_0$  is the impedance of free-space, 377 ohm.

Example for an electric field sensor

- $V_{3, \text{peak}} = 5 \text{ V}$
- $V_{4, \text{peak}} = 11.85 \text{ mV}$
- Attenuator: 40 dB
- Distance septum to ground plane: 82 mm

$$K_{\text{sensor}} = \frac{5 \cdot 10^{\frac{40}{20}}}{11.85 \cdot 0.082} = 0.51 \frac{\text{kV}}{\text{m}} / \text{mV} .$$

The correction factor is  $0.51 \frac{\text{kV}}{\text{m}} / \text{mV} .$

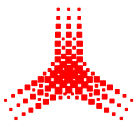

An example of typical waveforms is shown below:

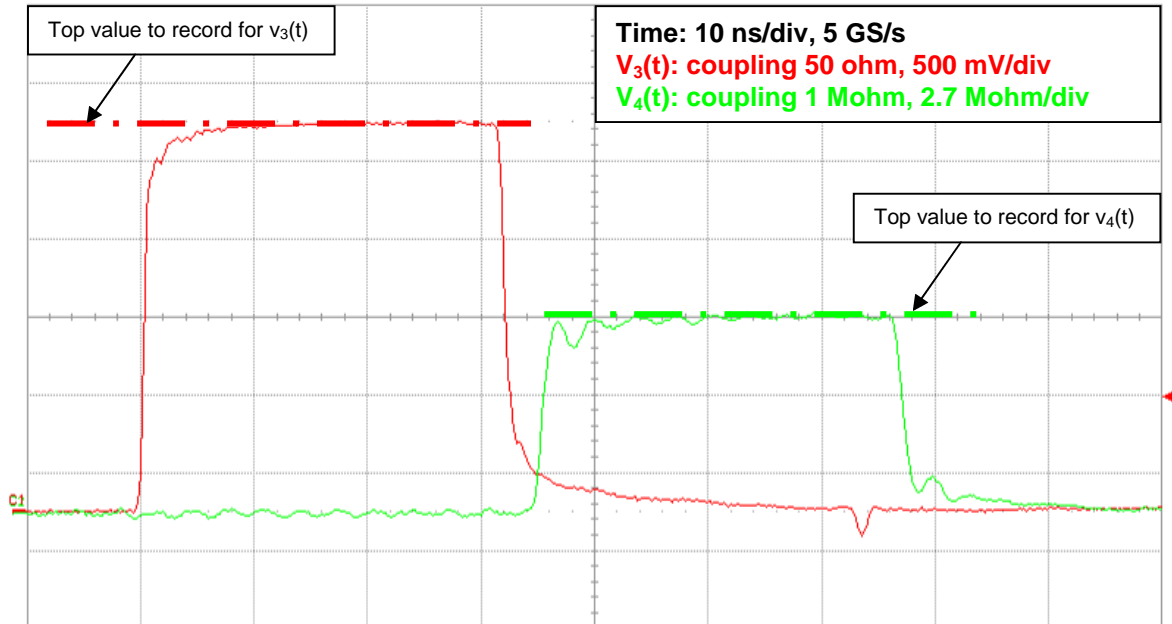

## 9. Verification procedure

1. Verification of the devices of the setup
  - a. Measurement of the pulse rise-time and duration of the generator.
  - b. Measurement of the transmission and reflection characteristics of the TEM cell with a network analyser.
  - c. Measurement of the distance between the septum and the ground plane of the TEM cell. Record as  $h_{\text{cell}}$ .
  - d. Measurement of the transmission characteristics of the attenuator and the coaxial cable 2. Record as  $K_{\text{att}}$ .
2. Preparation of the setup
  - a. Connect the pulse generator, the TEM cell, the attenuator, the coaxial cables and the oscilloscope as described in Paragraph 1.
  - b. Place the ground field sensor in the middle of the TEM cell and ensure a good connection with the ground plane of the TEM cell. Ensure the correct orientation of the field sensor.
  - c. Connect the ground field sensor cable to the integrator and the integrator to the oscilloscope.
3. Measurement of the voltages on the oscilloscope.
  - a. Set the pulse generator to the desired voltage and trigger a pulse.
  - b. Measurement of the top values of  $v_3(t)$  and  $v_4(t)$ .
  - c. Determination of the sensor correction factor with the equation (6) or (9).